

**JTS**®

LIGHTER  
SMALLER

MORE POWERFUL  
GUITAR / ACCORDING / WINDS / BRASS

**JTS**® PROFESSIONAL CO., LTD.  
No. 148, 9th Industry Road, Ta-Li Industrial Park,  
Taichung City, Taiwan, R.O.C.  
Tel: 886-4-24938803 Fax: 886-4-24914890  
E-mail: [jts@jts.com.tw](mailto:jts@jts.com.tw)  
[www.jts.com.tw](http://www.jts.com.tw)



FC CE    
59508-XXX-01



MINIATURE *MUSIC*  
*INSTRUMENTS*

WIRELESS SYSTEM

Instruction Manual

Thank you for choosing the JTS wireless system. In order to obtain the best efficiency from the system, you are recommended to read this instruction manual carefully.

# INDEX

1. Important Caution	01
2. Features	01
3. Specification	02
3-1-1 Receiver // RU-8011D/ RU-8011DB/ RU-8012DB	02
3-1-2 Receiver // RU-12	03
3-1-3 Receiver // RU-901G3	04
3-2 Miniature Transmitter// UT-16G3	05
4. Part Identification & Accessories	06
4-1-1 Receiver // RU-8011D	06
4-1-2 Receiver // RU-8011DB	08
4-1-3 Receiver // RU-8012DB	10
4-1-4 Receiver // RU-12	12
4-1-5 Receiver // RU-901G3	14
4-2 Miniature Transmitter // UT-16G3	16
4-3 Accessorie	18
5. Preparing Procedures & Basic Operation	14
5-1 Receiver	19
5-2 Battery Insertion of The Transmitter	20
5-3 Install The Transmitter	21
6. System Operation	23
6-1-1 Instructions // UT-16G3	23
6-1-2 Instructions // RU-8011D	26
6-1-3 Instructions // RU-8011DB	28
6-1-4 Instructions // RU-8012DB	31
6-1-5 Instructions // RU-12	34
6-1-6 Instructions // RU-901G3	40
7. Rack Mounting	43
8. Recommendation	44
9. Important Notice	45

# 1. Important Caution

- Before connecting to the power supply, make sure that the voltage marked on the host
- machine is the same as the power supply value on your outlet.
- Do not place the machine in damp or hot places.
- Dry your hands before operating the system.
- Keep the machine away from fire or heat sources.
- When multiple receivers are stacked at the same time, it is advised to select frequency
- points in the same group to avoid frequency interference.

# 2. Features

The newly designed UT-16G3 wireless instrument microphone is equipped with JTS patented technology **REMOSET ũ** with the ultrasonic wireless transmission function for users to choose wireless synchronization parameters or set parameters manually. Advanced circuit design ensures stable signal output and reduces noise interference. 36MHz broadband design provides more optional frequencies and can be used with RU-901G3/RU-12/RU-8011D/RU-8011DB/RU-8012DB and other **REMOSET ũ** models.

# 3. Specification

## 3-1-1 UHF PLL single/dual-channel diversity receiver // RU-8011D(DB) / RU-8012DB

Model	<b>RU-8011D</b>	<b>RU-8011DB</b>	<b>RU-8012DB</b>
Frequency Oscillation Mode	Phase-locked loop (PLL)		
Carrier Frequency Range	470~960 MHz		
Remoset Frequency	Ultrasonic		
Diversity	Antenna diversity		
Bandwidth	36MHz		
Signal/Noise Ratio	>105dB(A)		
Total Harmonic Distortion (Thd)	<0.6%@1KHz		
Receiving Sensitivity	-95dBm , S/N>80dB		
Image Rejection Ratio	>80 dB		
Frequency Response	60Hz~15KHz±2dB	50Hz~16KHz±2dB	
Antenna Type	1/4λ Fixed antenna	1/2λ BNC detachable	
Antenna Booster Power	None	DC12~15V/100mA	
Function Display By	LCD		
Contents Of Display	Group, channel, antenna A/B, muting level, AF indication, RF indication, channel scanning, output level attenuation, volume indication	Group, channel, frequency, battery level, antenna A/B, muting level, AF indication, RF indication, channel scanning, output level attenuation, volume indication	
Control Functions	Power, group, channel, muting level, channel scan (on/off), button lock, volume, output attenuation (XLR)	Power, group, channel, frequency, muting level, button lock, volume, output attenuation (XLR), channel scan (on/off)	
Audio Frequency Output Level	Ref : ±22.5KHz Dev@1KHz Tone		
	ψ6.3 Phone Jack : -10dBV		
	XLR Jack : -4dBV(Line) 、 -24dBV(MIC)		
Audio Frequency Output Impedance	600Ω		

### 3-1-2 UHF PLL dual-channel diversity receiver // RU-12

Model	<b>RŪ-12</b>
Frequency Oscillation Mode	Phase-locked loop (PLL)
Carrier Frequency Range	470~960 MHz
Remoset Frequency	Ultrasonic
Diversity	Antenna diversity
Bandwidth	36MHz
Signal/Noise Ratio	>105dB(A)
Total Harmonic Distortion (Thd)	<0.6%@1KHz
Receiving Sensitivity	-95dBm · S/N>80dB
Image Rejection Ratio	>80 dB
Frequency Response	50Hz~16KHz±2dB
Antenna Type	1/2λ BNC detachable
Antenna Booster Power	DC12~15V/100mA
Function Display By	LCD
Contents Of Display	Group, channel, frequency, battery level, antenna A/ B, muting level, AF indication, RF indication, channel scanning, output level attenuation, volume indication
Control Functions	Power, group, channel, frequency, muting level, button lock, volume, output attenuation (XLR), channel scan (on/off)
Audio Frequency Output Level	Ref : ±22.5KHz Dev@1KHz Tone
	ψ6.3 Phone Jack : -10dBV
	XLR Jack : -4dBV(Line) 、 -24dBV(MIC)
Audio Frequency Output Impedance	600Ω
Muting	Noise muting and tone code locking
Output Port	2 x balanced XLR jack 2 x unbalanced φ6.3 jack
Power Supply	12~15V DC / 500mA
Dimension (Mm)	212.3mm (W) x 38.3mm (H) x 144mm (L)

### 3-1-3 UHF PLL single-channel True Diversity receiver // RU-901G3

Frequency Oscillation Mode	Phase-locked loop (PLL)
Carrier Frequency Range	470~960 MHz
Remoset Frequency	Ultrasonic
Diversity	True diversity
Bandwidth	36MHz
Signal/Noise Ratio	>105dB(A)
Total Harmonic Distortion (Thd)	<0.6%@1KHz
Receiving Sensitivity	-95dBm , S/N>80dB
Image Rejection Ratio	>80 dB
Frequency Response	50Hz~18KHz±2dB
Antenna Type	1/2λ BNC detachable
Antenna Booster Power	DC12~15V/100mA
Function Display By	LCD
Contents Of Display	Group, channel, frequency, battery level, antenna A/B, muting , AF indication, RF indication, channel scanning, output level attenuation
Control Functions	Power, group, channel, frequency, muting , button lock, volume, output attenuation (XLR), channel scan (on/off)
Audio Frequency Output Level	ψ6.3 Phone Jack : -10dBV XLR Jack : -4dBV(Line) 、-24dBV(MIC)
Audio Frequency Output Impedance	600Ω
Muting	Noise muting and tone code locking
Output Port	1 x balanced XLR jack 1 x unbalanced φ6.3 jack
Power Supply	12~15V DC / 500mA
Dimension (Mm)	212.3mm (W) x 38.3mm (H) x 144mm (L)



### 3-2 Miniature Transmitter // UT-901G3

Model	UT-901G3
Frequency Oscillation Mode	PLL Synthesized Control
Carrier Frequency Range	470~960 MHz
Frequency Setting	Ultrasonic / Remoset U (Receive)
RF Outputs	Maximum 10mW
Stability	$<\pm 10\text{KHz}@F_c$
Frequency Deviation	$\pm 48\text{KHz}$
Spurious Emissions	$<-50\text{dBc}$
Function	Power ON/OFF, Mute, Group, Channel, Frequency, Sensitivity, Key Lock
Display	LCD
Input Connector	3.5mm Plug (6.35mm Adapter)
Battery	UM3, AA x2
Note	Actual Product specifications may vary depending on model and region

# 4. Part Identification & Accessories

## 4-1-1 UHF PLL single-channel diversity receiver // RŨ-8011D

Front panel

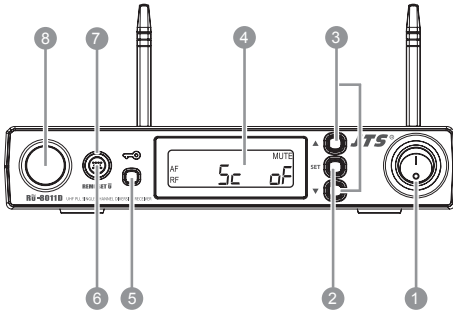

Rear panel

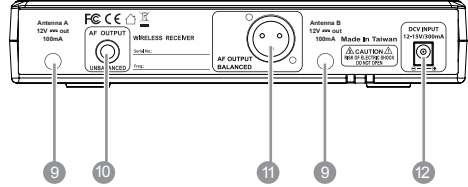



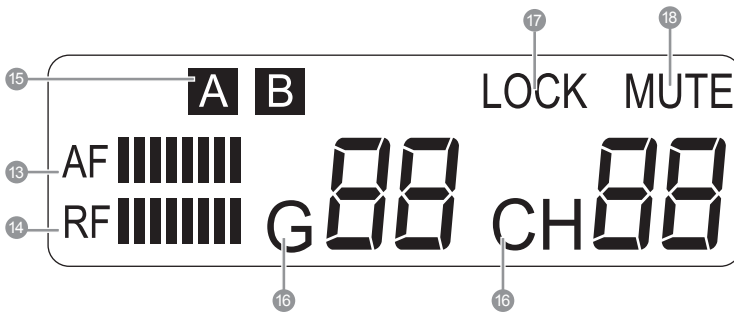

- 1 Power: | means "ON" and O means "OFF"
- 2 SET: this is for function settings. Push and hold for 2 seconds to enter the setting mode. Push "SET" repeatedly to search for the function you wish to set.
- 3 ▲/▼ In the setting mode, push▲/▼to change the function parameter  
In the non-setting mode: push▲/▼to adjust volume
- 4 LCD display
- 5 Lock :push and hold "Lock" for 2 seconds to lock the buttons in order to prevent pushing any button by accident.
- 6 Remoset u : this allows user to synchronize the transmitter after modifying a parameter. Push " **REMOSET Ũ** " to synchronize the settings to the transmitter.
- 7 Remoset indicator : this shows the current pairing status. It flashes rapidly when data is being transmitted and the flashing stops when the synchronization is completed. However, the flashing slows down if synchronization fails after a period of time of pairing attempt.
- 8 Ultrasonic transmission unit: it transmits digital pairing data at ultrasonic frequency. When setting, direct the ultrasonic receiving element of the microphone to the ultrasonic transmitting unit of the receivers. The effective range is 30° on both sides with the optimized distance at 30cm.
- 9 Receiving antenna: fixed antenna of 1/4 wave length
- 10 6.3mm phone jack: unbalanced audio output jack
- 11 3P XLR male: balanced audio output jack
- 12 DC power socket: for 12~15V DC / 300mA power supply

## RÜ-8011D LCD Display



In the non-setting mode, the LCD looks like :

- ⑬ AF  : Audio signal strength
- ⑭ RF  : RF signal strength
- ⑮ **A B** : Antenna A/B
- ⑯ G  / CH  : Group / channel
- ⑰ LOCK : Button lock engaged
- ⑱ MUTE : Receiver mute

4-1-2 UHF PLL single-channel diversity receiver // **RŪ-8011DB**

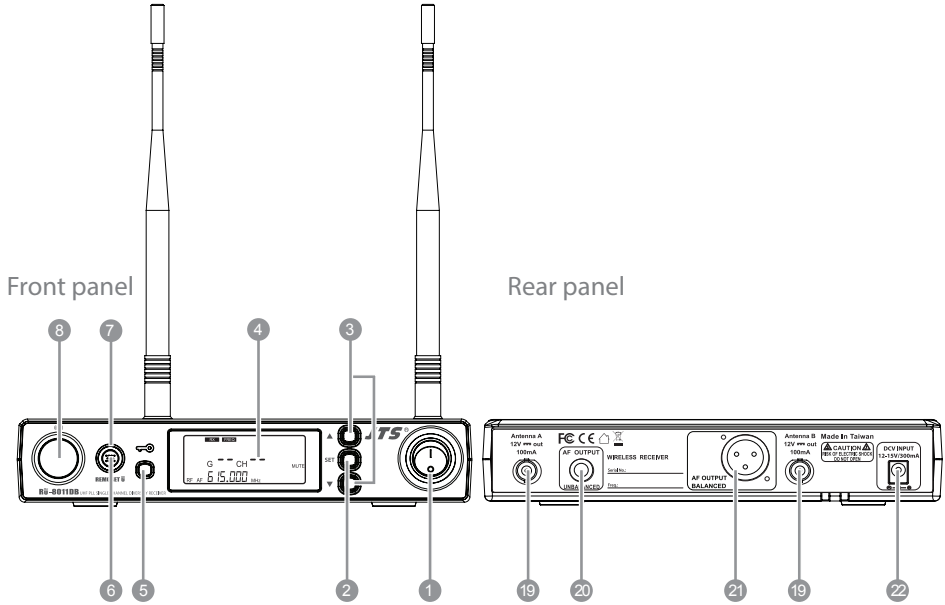

① ~ ⑧ : See page 5.

⑱ Female BNC antenna port: the 50Ω BNC antenna is connected here. It also provides a booster power of 12~15 DC / 100mA for an external antenna booster.

⑳ 6.3mm phone jack: unbalanced audio output jack



㉑ 3P XLR male: balanced audio output jack

㉒ DC power socket: for 12~15V DC / 300mA power supply

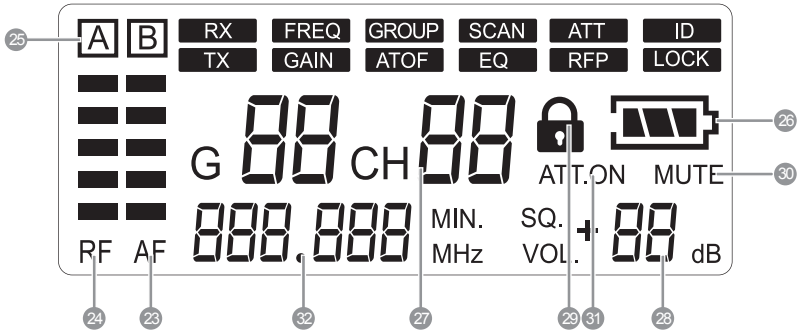
## R0-8011DB LCD Display



In the non-setting mode, the LCD looks like :

- 23 AF : Audio signal strength
- 24 RF : RF signal strength
- 25 **A B** : Antenna A/B
- 26  : Transmitter battery level
- 27 **G 00 / CH 00** : Group/channel
- 28 **VOL. + 00 dB** : Volume
- 29  : Button lock
- 30 MUTE : Receiver mute
- 31 ATT.ON : Output attenuation
- 32 **000.000 MHz** : Frequency

### 4-1-3 UHF PLL dual-channel diversity receiver // **RŪ-8012DB**

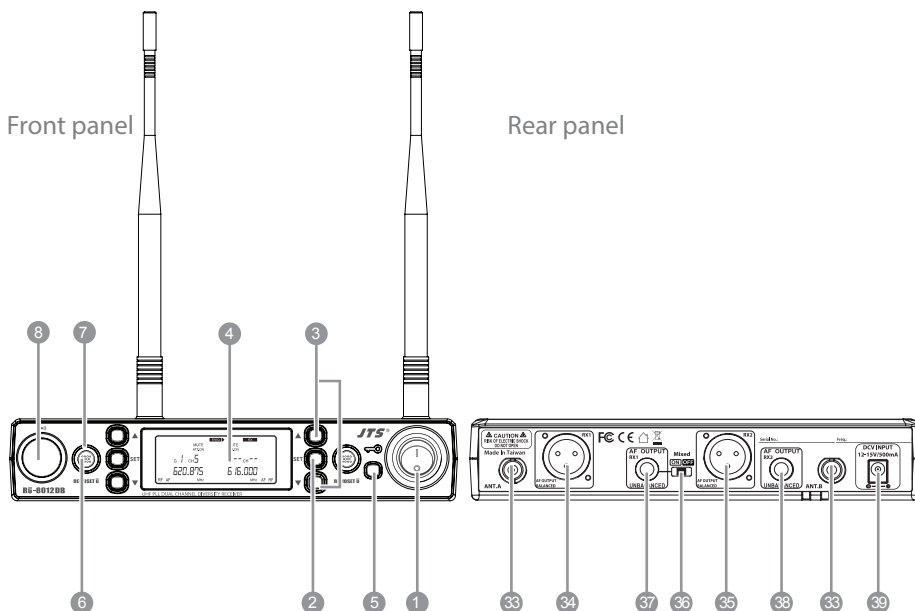

1 ~ 8 : See page 5.

- 33 Female BNC antenna port: the 50Ω BNC antenna is connected here. It also provides a booster power of 12~15 DC / 100mA for an external antenna booster.
- 34 Male XLR (RX1): RX1 balanced audio output jack
- 35 Male XLR (RX2): RX2 balanced audio output jack
- 36 Mixing: it allows the unbalanced audio signals from RX1 and RX2 to be mixed to RX1.
- 37 6.3mm phone jack (RX1): RX1 unbalanced audio output jack
- 38 6.3mm phone jack (RX2): RX2 unbalanced audio output jack
- 39 DC power socket: for 12~15V DC / 500mA power supply

## RŪ-8012DB LCD Display

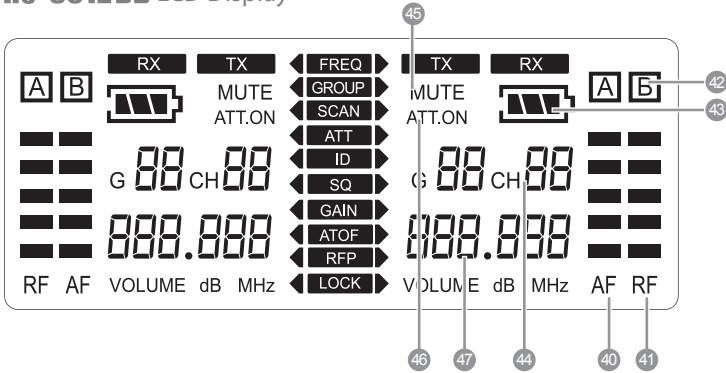

In the non-setting mode, the LCD looks like this:

- ④① AF : Audio signal strength
- ④① RF : RF signal strength
- ④② **A B** : Antenna A/B
- ④③  : Transmitter battery level
- ④④ G 88 / CH 88 : Frequency (group/channel)
- ④⑤ MUTE : Receiver mute
- ④⑥ ATT.ON : Output attenuation
- ④⑦ 888.888 MHz : Frequency

## 4-1-4 UHF PLL dual-channel diversity receiver // **RŪ-12**

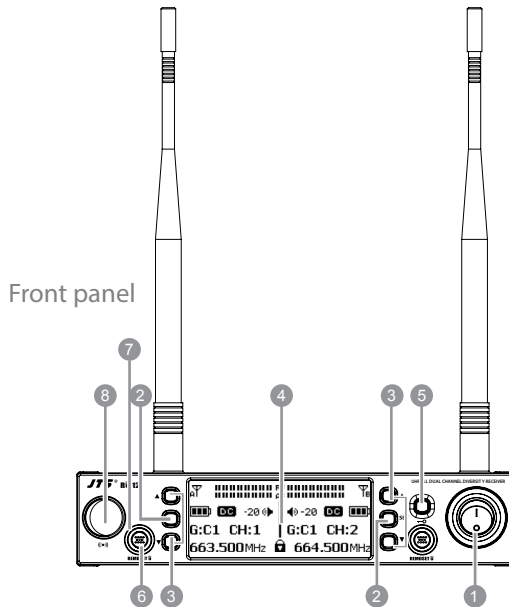

- ① Power: | means "ON" and ○ means "OFF"
- ② SET: this is for function settings. Push and hold for 2 seconds to enter the setting mode. Push "SET" repeatedly to search for the function you wish to set.
- ③ ▲/▼ In the setting mode, push ▲/▼ to change the function parameter  
In the non-setting mode: push ▲/▼ to adjust volume
- ④ LCD display
- ⑤ Lock : push and hold "Lock" for 2 seconds to lock the buttons in order to prevent pushing any button by accident.
- ⑥ Remoset Ū : this allows user to synchronize the transmitter after modifying a parameter. Push " **REMOSET Ū** " to synchronize the settings to the transmitter.
- ⑦ Remoset indicator : this shows the current pairing status. It flashes rapidly when data is being transmitted and the flashing stops when the synchronization is completed. However, the flashing slows down if synchronization fails after a period of time of pairing attempt.
- ⑧ Ultrasonic transmission unit: it transmits digital pairing data at ultrasonic frequency. When setting, direct the ultrasonic receiving element of the microphone to the ultrasonic transmitting unit of the receivers. The effective range is 30° on both sides with the optimized distance at 30cm.



## Rear panel

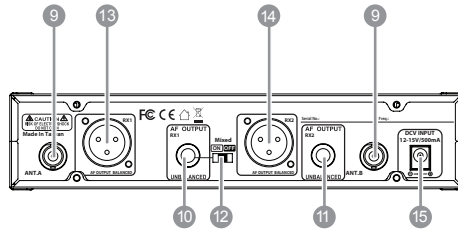

- ⑨ Female BNC antenna port: the 50Ω BNC antenna is connected here. It also provides a booster power of 12~15 DC / 100mA for an external antenna booster.
- ⑩ Male XLR (RX1): RX1 balanced audio output jack
- ⑪ Male XLR (RX2): RX2 balanced audio output jack
- ⑫ Mixing: it allows the unbalanced audio signals from RX1 and RX2 to be mixed to RX1.
- ⑬ 6.3mm phone jack (RX1): RX1 unbalanced audio output jack
- ⑭ 6.3mm phone jack (RX2): RX2 unbalanced audio output jack
- ⑮ DC power socket: for 12~15V DC / 500mA power supply





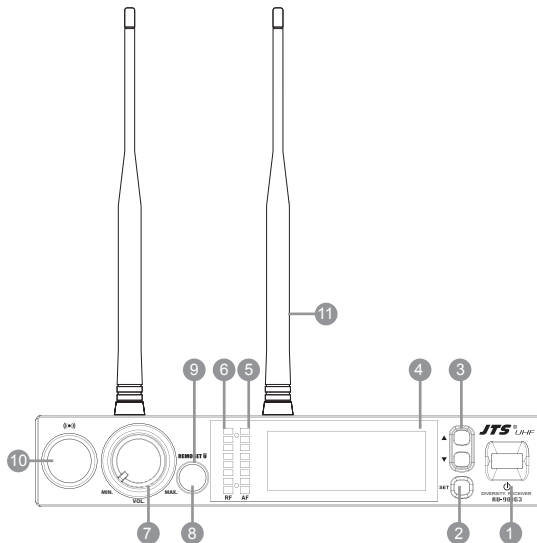

## 4-1-5 UHF PLL single-channel diversity receiver( True Diversity ) // RU-901G3

### Front panel

- ① **Power On/Off switch:** Press once to turn on the power,press and hold for 2 seconds to turn off.
- ② **SET:** this is for function settings. Push and hold for 2 seconds to enter the setting mode. Push "SET" repeatedly to search for the function you wish to set.
- ③ **▲/▼**In the setting mode, push▲/▼to change the function parameter  
In the non-setting mode: push▲/▼to adjust volume
- ④ **LCD display**
- ⑤ **AF signal level**
- ⑥ **RF signal level**
- ⑦ **Volume control**
- ⑧ **Remoset Button :** this allows user to synchronize the transmitter after modifying a parameter. Push " **REMOSET** " to synchronize the settings to the transmitter.
- ⑨ **Remoset indicator :** this shows the current pairing status. It flashes rapidly when data is being transmitted and the flashing stops when the synchronization is completed. However, the flashing slows down if synchronization fails after a period of time of pairing attempt.
- ⑩ **Ultrasonic transmission unit:** it transmits digital pairing data at ultrasonic frequency. When setting, direct the ultrasonic receiving element of the microphone to the ultrasonic transmitting unit of the receivers. The effective range is 30° on both sides with the optimized distance at 30cm.
- ⑪ **Antenna**



In the non-setting mode, the LCD looks like :

- 12  : Antenna A/B
- 13  : Transmitter battery level
- 14 G  / CH  : Group/channel
- 15  : Key Lock
- 16 MUTE : Receiver mute
- 17 ATT.ON : Output attenuation
- 18 SQ. : Squelch level
- 19  MHz : Frequency

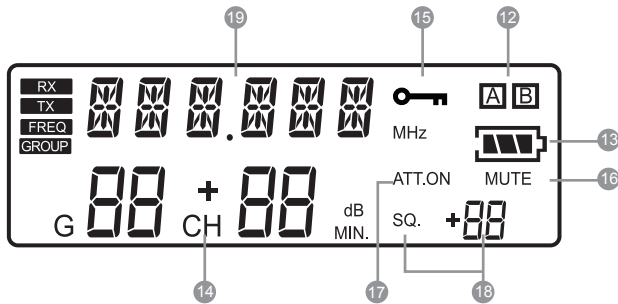

### Rear panel

- 20 **DC power socket:** for 12~15V DC / 500mA power supply
- 21 **Female BNC antenna port:** the 50Ω BNC antenna is connected here. It also provides a booster power of 12~15 DC / 100mA for an external antenna booster.
- 22 **6.3mm phone jack:** unbalanced audio output jack
- 23 **3P XLR male:** balanced audio output jack

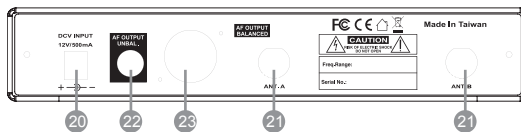

## 4-2 Miniature Transmitter

① Power button/mute button:

On: Press the button to turn on the power and press it again for the mute mode

Off: Press the power button for 2 seconds until the screen shows power off

② Ultrasound receiving hole: receiving binding signals from the ultrasound transmitting unit of the receiver.

③ LED status indicator light:

(1) Green: full battery  $>1V$

(2) Green flash: transmitter in mute mode

(3) Red: low battery  $\leq 1V$

(4) Alternating flashing red and green: microphone in mute mode (low battery)

(5) Blue: flashing for 3 seconds indicates success in binding alignment

(6) Blue flash: error receiving data

④ LED display: displaying the relevant content and parameters of the transmitter

⑤ Set key: setting content parameters, including: frequency, group, channel, sensitivity, digital audio code, key lock

⑥ Up/Down key: Using the "SET" key to change parameter setting

⑦ Audio plug:  $\psi 3.5mm$  (6.35mm Adapter)

⑧ Battery cell: supporting AM4, AAA 1.5V\*1 alkaline or rechargeable batteries

⑨ Antenna: RF antenna

⑩ Input sensitivity adjustment

⑪ UT-16GT transmitter

⑫ Battery cover (color) trim cover: green/gray

⑬ 6.3GT plug: plug

⑭ 516GT: accordion microphone module

508GT: microphone module for wind instruments



⑮ 16GT Clip: Wind instrument clamp

⑯ 516 Bracket

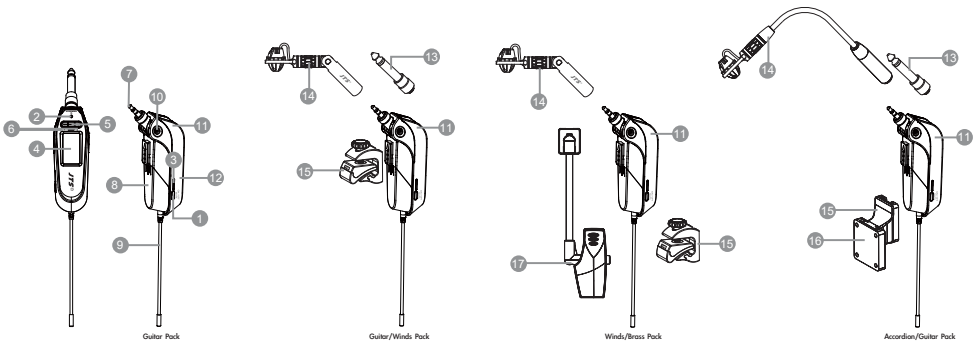
⑰ CLP-UT



Display content in non-set mode:

- ①  : RF emission instruction
- ②  : KeyLock ON
- ③  : Battery indicator
- ④ **DG** : DigiCode ON
- ⑤ **MUTE** : Mute ON
- ⑥ **MHZ** : Frequency MHz

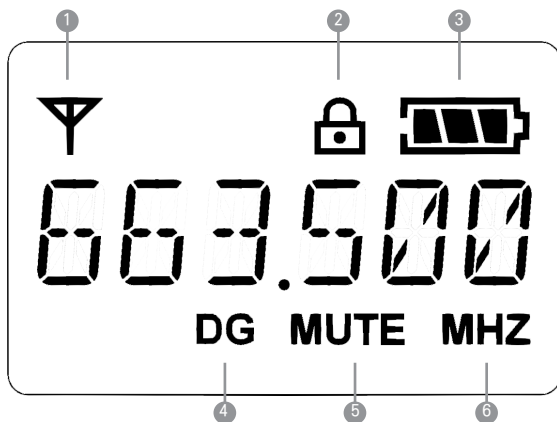

## 4-3 Accessories

- ① AC/DC transformer
  - Ⓐ Switching power supply (100V~240V , 50~60Hz)
  - Ⓑ Linear power supply (220V, 50Hz)
  - Ⓒ Linear power supply (220V, 60Hz)
- ② AF output wire
- ③ Regulating rod
- ④ Chuck
- ⑤ DR-900 dual-hole receiver holder Optional
- ⑥ RP-900 holder hood Optional
- ⑦ Double-faced tape \*2
- ⑧ Windscreen

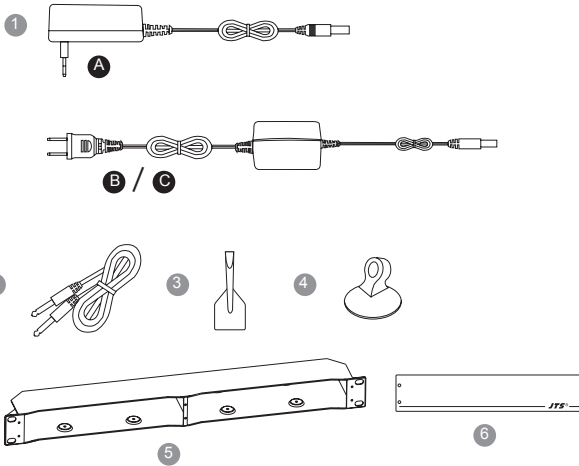

⑦  ※ Apply double-faced tape to the upper and lower covers of the audio head to prevent the windshield from falling off easily. The fitting positions are shown in figures 1 and 2 below

⑧  ※Tear off the white non-adhesive surface of two pieces of double-faced tape and attach the windproof cover to the upper and lower covers of the audio head in the front-rear direction, as shown in Figure 3 below:

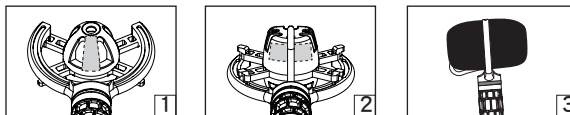

# 5. Preparing Procedures & Basic Operation

## 5-1 Receiver

- (1) Connect to the subsequent unit (e.g. mixer, or amplifier)  
Connect one end of a proper AF cable to the AF Output or Balanced XLR Output socket, then plug another end to the "MIC IN" input socket of a mixer or a amplifier (Step 1)
- (2) Connect the power supply unit  
Plug in one end of AC/DC adaptor cable to Power Supply Jack in the rear panel of receiver, and plug another end into an AC outlet (Step 2)

### Caution

To prevent accidental disconnection of the plug from the jack, lead the cable around the hook of the strain relief.

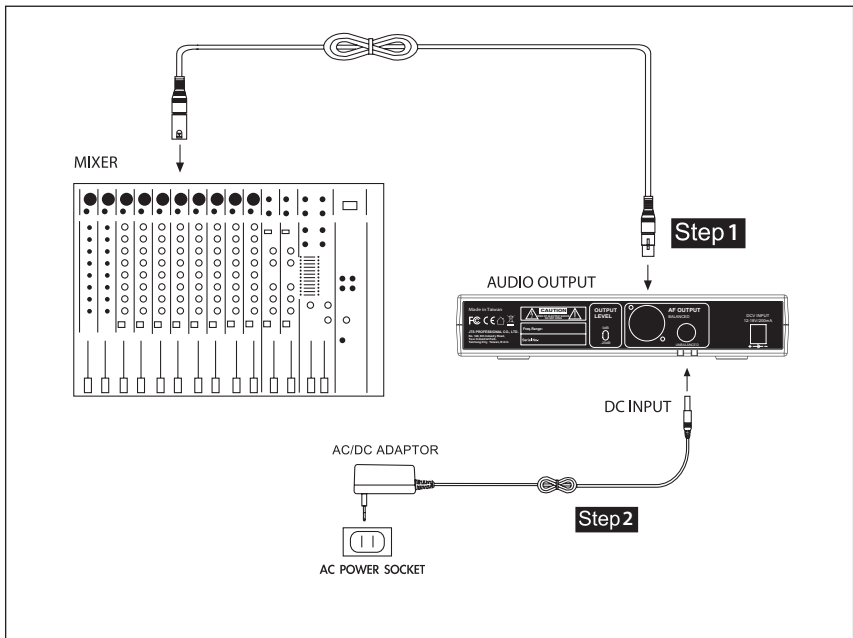

## 5-2 Install transmitter battery

- (1) Press the battery cover ① and slide out.
- (2) Insert or replace a battery based on its polarity.
- (3) Switch the power ② to ON. If the battery level is high, the LED indicator ③ will emit green light. Once the battery is low, the LED indicator ③ will turn red, and the remaining power will last only 30 minutes.
- (4) Put back the battery cover.

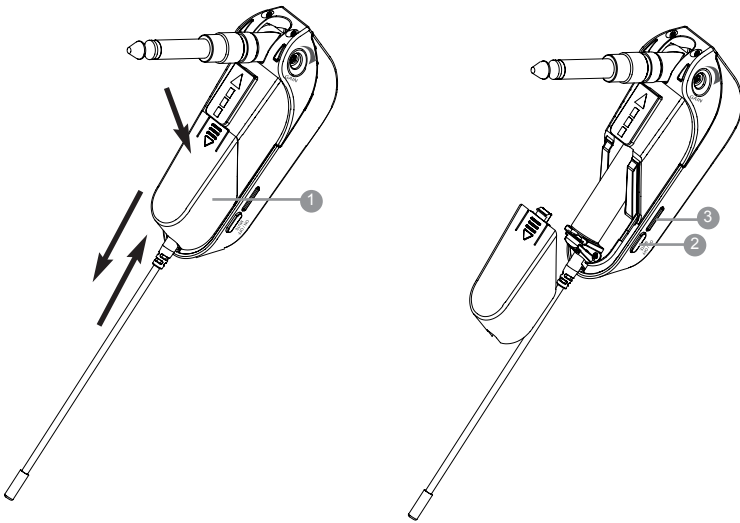



### 5-3 Install transmitter

(1) Use UT-16G3+6.3GT plug in electric guitar

1. Insert the 6.3GT plug into the transmitter and screw it to the end.
2. Insert the transmitter into the output hole of the electric guitar sound source.
3. When inserted into the output hole of the electric guitar sound source, the transmitter should be pushed to the end to fix it.
4. A chuck (1) is also used to fix the transmitter antenna to prevent the transmitter from shaking.

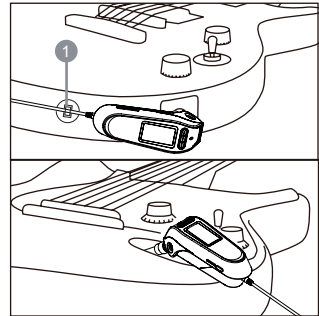
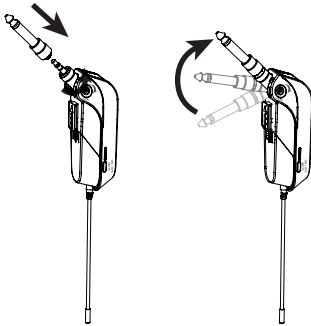

(2) Use 516GT/508GT for wind instruments/accordions

- ① Insert 516GT/508GT into the transmitter and screw it firmly to the bottom.
- ② Turn the screw on the 16GT Adapter/16GT CLIP/ CLP-UT clockwise to attach the transmitter to the instrument.
- ③ Fix 16GT Adapter + 516 Bracket on the accordion.
- ④ Secure 16GT CLIP/CLP-UT to proper position
- ⑤ Adjust 516GT/508GT to appropriate position

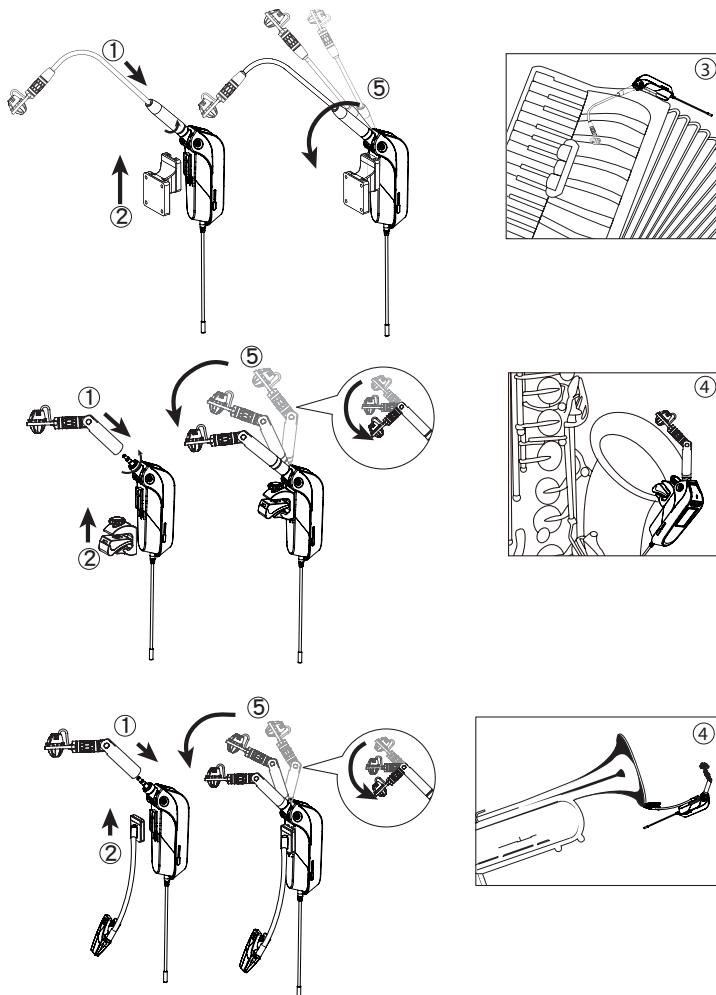

# 6. System Operation

## 6-1-1 Operation // UT-16G3

Parameter setting \_\_\_\_\_

Press SET button for 2 seconds to enter the set menu, press ▲/▼ to select the item to be set, and press SET for setting.



### ◎ FREQ frequency setting

Unit: 1MHz	Press ▲/▼ to set frequency
Unit: 0.025MHz	Press ▲/▼ to set frequency

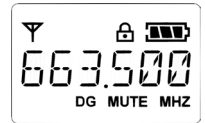

### ◎ GROUP/Channel setting

G	Select default groups 1 to 6
CH	Select the default channel, up to 22

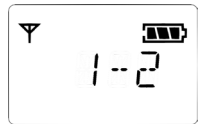
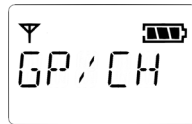

### ◎ Sensitivity: Microphone input sensitivity

Normal sensitivity	GAIN : +15dB
	GAIN : +12dB
	GAIN : +9dB
	GAIN : +6dB
	?
	GAIN : +3dB
	GAIN : 0dB
	GAIN : -3dB
	?
	GAIN : -6dB
	GAIN : -9dB
	GAIN : -12dB
	GAIN : -15dB

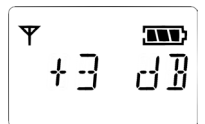
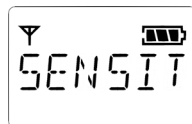

© Digital audio code

OFF	Function is deactivated
ON	Function is activated

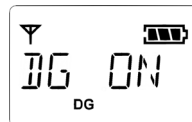
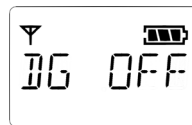
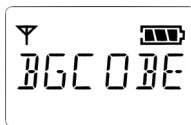

© Reset

Yes	Reset to original manufacture settings
No	Cancel

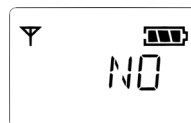
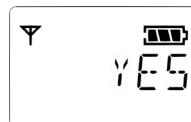
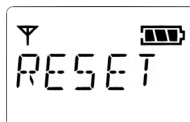

© Key lock

Loc OFF	Lock OFF
Loc SET	Only lock the setting function; power and mute control are available
Loc ALL	Lock all keys, power and mute control are not available
Unlocking method	Press the SET key for 2 seconds to enter the setting page and select Lock OFF to unlock it.

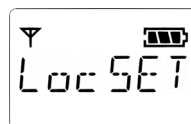

© Exit setting

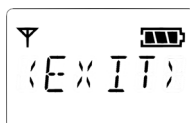

## Binding **REMOSET**

When relevant parameters are set, press the **REMOSET**  key to transmit the digital binding data to the transmitter by using the ultrasonic transmitter, while setting relevant parameters synchronously. When data is being transmitted, the indicator flashes quickly. When the synchronization is completed, the receiver receives the corresponding channel or frequency, and the light will stop immediately. If no signal is received after a period of time, the light will flash slowly, informing the user of the failure of binding (the slow flash can be cancelled by pressing any key).

Note: The optimum binding distance is 10~60cm,  $\pm 30^\circ$ .

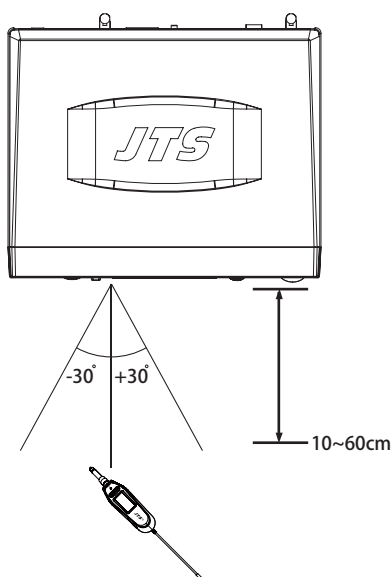

Note 2: Only one transmitter can be synchronized at the same time. When RX1 is synchronized, RX2 cannot use the synchronization function until the completion of synchronization of RX1.

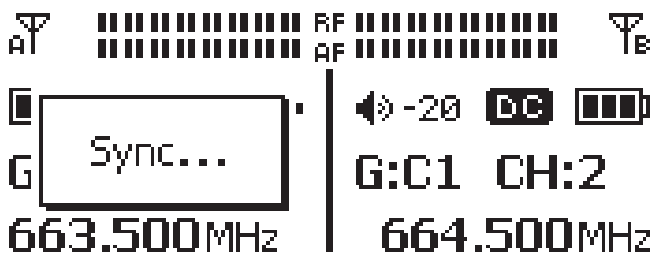

6-1-2 How to use // **Rũ-8011D**

**Parameter setting**

Push and hold the “SET” button to enter the setting mode.

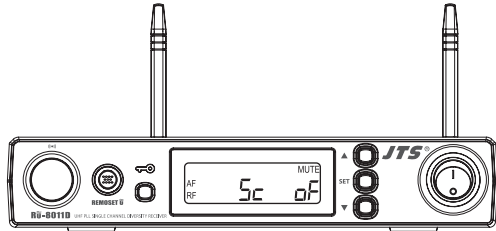

⊙ Group / channel setting

G: group	Select default group 1~6
CH : channel	Select default channel, 1~22 max

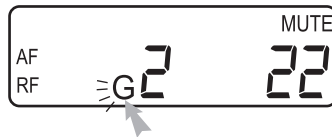

Select the group when “G” is flashing; select the channel when “CH” is flashing.

⊙ Channel scan

SC oF	This means the function is deactivated.
SC on	This means the function is activated. (scan to make sure this channel is occupied or not)The program will avoid it automatically to prevent interference.



This function is deactivated.

⊙ Audio output attenuation (XLR)

At oF	No attenuation at audio output
At on	20dB attenuation at audio output



This function is deactivated.

⊙ SQ receiving sensitivity

-5~+10dB; select SQ with ▲/▼	-5 is the maximum sensitivity.
	+10 is the minimum sensitivity.
	The default setting is 0.



The default setting is 0.

⊙ Microphone input sensitivity

Normal sensitivity	SE A : +15dB SE 9 : +12 dB SE 8 : +9dB SE 7 : +6dB SE 6 : +3 dB SE 5 : 0 dB SE 4 : -3 dB SE 3 : -6 dB SE 2 : -9 dB SE 1 : -12 dB SE 0 : -15 dB
20dB attenuation (body pack transmitter only)	SE AA : -5 dB SE A9 : -8 dB SE A8 : -11dB SE A7 : -14dB SE A6 : -17dB SE A5 : -20dB SE A4 : -23dB SE A3 : -26dB SE A2 : -29dB SE A1 : -32dB SE A0 : -35dB



Normal default sensitivity



20dB attenuation

⊙ ATOF: Automatic microphone off countdown under mute status

AO OF	This function is deactivated
AO 1	1 minute countdown to turn off
AO 10	10 minute countdown to turn off
AO 30	30 minute countdown to turn off

(The default setting is 10 minute.)



This function is deactivated.

⊙ RFP: RF microphone power

The transmitter comes with 2 stages of RF power output.

rF Lo	10mW
rF Hi	50mW



This shows that the RF output is LOW (10mW).

⊙ RC (Remoset Configuration)

rC Fr	Only frequency and group setting will be synchronized
rC AL	All data setting will be synchronized

The default setting is rC Fr.

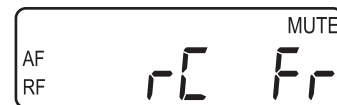

Only frequency and group setting will be synchronized.

## 6-1-3 How to use // **RÜ-8011DB**

### Parameter setting

Push and hold the “SET” button to enter the setting mode. Push the ▲/▼ button to choose to set RX (receiver) or TX (transmitter).

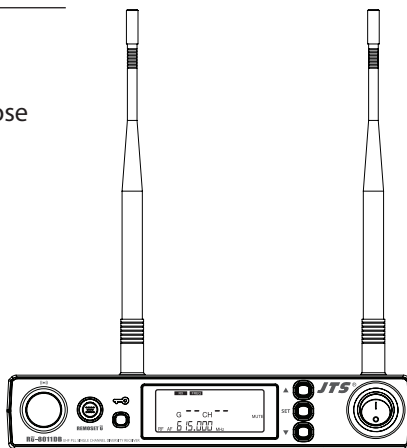

When RX receiver is selected:

#### ◎ FREQ: frequency setting

In 1MHz	Select frequency with ▲/▼
In 0.025MHz	Select frequency with ▲/▼



Select the number of frequency first in MHz and then in 0.025MHz.

#### ◎ Group / channel

G: group	Select default group 1~6
CH: channel	Select default channel, 1~22 max

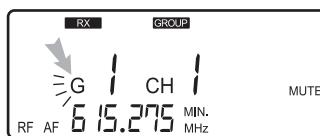

Select the group when “G” is flashing; select the channel when “CH” is flashing.

#### ◎ Channel scan

SC off	This means the function is deactivated.
SC on	This means the function is activated. (scan to make sure this channel is occupied or not) The program will avoid it automatically to prevent interference.



This function is deactivated.

Note: this function works only in the preset mode.



⊙ Audio output attenuation (XLR)

At off	No attenuation at audio output
At on	20dB attenuation at audio output



This function is deactivated.

⊙ SQ Receiving sensitivity

-5~+10dB; select SQ with ▲/▼	-5 is the maximum sensitivity.
	+10 is the minimum sensitivity.
	The default setting is 0.



The default setting is 0.

**When TX transmitter is selected:**

⊙ ATT microphone audio input attenuation

At off	No attenuation at audio input
At on	20dB attenuation at audio input (depending on whether the transmitter is provided with the corresponding function).

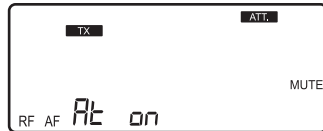

The function is activated with 20dB of audio input attenuation.

⊙ Microphone input sensitivity

Normal sensitivity	GAIN : +15dB
	GAIN : +12dB
	GAIN : +9dB
	GAIN : +6dB
	GAIN : +3dB
	GAIN : 0dB
	GAIN : -3dB
	GAIN : -6dB
	GAIN : -9dB
	GAIN : -12dB
	GAIN : -15dB



It shows the microphone input sensitivity is now at 0dB (default setting).

⊙ ATOF: Automatic microphone off countdown under mute status

AO OF	This function is deactivated
AO 1	1 minute countdown to turn off
AO 10	10 minute countdown to turn off
AO 30	30 minute countdown to turn off

(The default setting is 10 minute.)

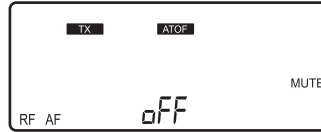

This function is deactivated.

⊙ RFP: RF microphone power

The transmitter comes with 2 stages of RF power output (as per local regulations).

rF Lo	10mW
rF Hi	50mW

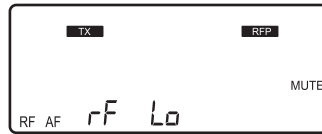

This shows that the RF output is LOW (10mW)

⊙ RC (Remoset Configuration)

rC-FrE	Only frequency and group setting will be synchronized
rC-ALL	All data setting will be synchronized

The default setting is rC-FrE.

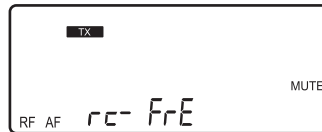

Only frequency and group setting will be synchronized.

## Volume adjustment

In non-setting mode, adjust the volume from 0 to -31dB using the ▲/▼ button.

- The minimum volume is -31 dB.
- The maximum volume is 0 dB.
- The default setting is -10 dB.

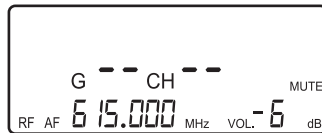

Minimum volume at -31db; maximum volume at 0dB

## Pairing **REMOSET**

See page 25.

## 6-1-4 How to use // **RÜ-8012DB**

### Parameter setting

Push and hold the “SET” button to enter the setting mode. Push the ▲/▼ button to choose to set RX (receiver) or TX (transmitter).

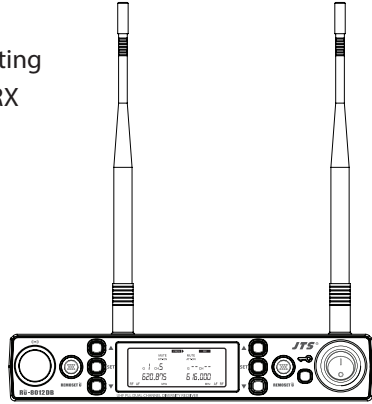

When RX receiver is selected:

#### ◎ **FREQ:** frequency setting

In 1MHz	Select frequency with ▲/▼
In 0.025MHz	Select frequency with ▲/▼

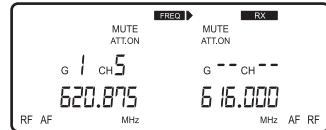

Select the number of frequency first in MHz and then in 0.025MHz.

#### ◎ **Group / channel**

G: group	Select default group 1~6
CH: channel	Select default channel, 1~22 max

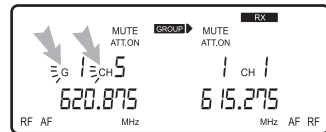

Select the group when “G” is flashing; select the channel when “CH” is flashing.

#### ◎ **Channel scan**

SC OFF	This means the function is deactivated.
SC on	This means the function is activated (scan to make sure this channel is occupied or not. The program will avoid it automatically to prevent interference.

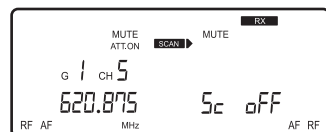

This function is deactivated.

Note: this function works only in the preset mode.

⊙ Audio output attenuation (XLR)

At off	No attenuation at audio input
At on	20dB attenuation at audio input (depending on whether the transmitter is provided with the corresponding function) .

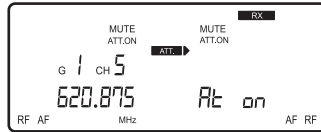

The function is activated with 20dB of audio input attenuation.

⊙ SQ Receiving sensitivity

-5~+10dB; select SQ with ▲/▼	-5 is the maximum sensitivity.
	+10 is the minimum sensitivity.
	The default setting is 0.

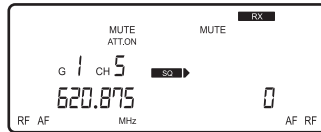

It shows the SQ is 0dB (default setting).

When TX transmitter is selected:

⊙ ATT microphone audio input attenuation

At off	No attenuation at audio input
At on	20dB attenuation at audio input

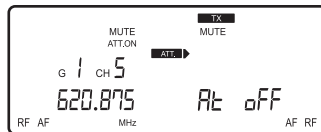

This function is deactivated.

⊙ Microphone input sensitivity

Normal sensitivity	GAIN : +15dB
	GAIN : +12dB
	GAIN : +9dB
	GAIN : +6dB
	GAIN : +3dB
	GAIN : 0dB
	GAIN : -3dB
	GAIN : -6dB
	GAIN : -9dB
	GAIN : -12dB
GAIN : -15dB	

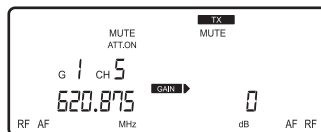

It shows the microphone input sensitivity is now at 0dB (default setting).

⊙ ATOF: Automatic microphone off countdown under mute status

OFF	This function is deactivated
1	1 minute countdown to turn off
10	10 minute countdown to turn off
30	30 minute countdown to turn off

(The default setting is 10 minute.)

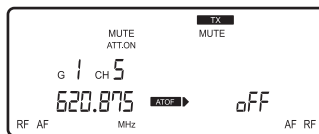

This function is deactivated.

⊙ RFP: RF microphone power

*The transmitter comes with 2 stages of RF power output (as per local regulations).*

rF Lo	10mW
rF Hi	50mW

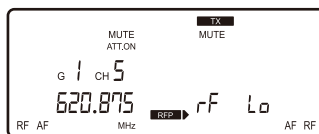

This shows that the RF output is LOW (10mW).

⊙ RC (Remoset Configuration)

rC-FrE	Only frequency and group setting will be synchronized
rC-ALL	All data setting will be synchronized

The default setting is rC-FrE.

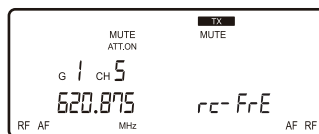

Only frequency and group setting will be synchronized.

## Volume adjustment

In non-setting mode, adjust the volume from 0 to -31 dB using the ▲/▼ button.

- The minimum volume is -31 dB.
- The maximum volume is 0 dB.
- The default setting is -10 dB.

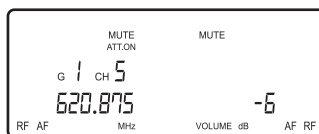

Minimum volume at -31db; maximum volume at 0db

## Pairing **REMOSET**

See page 25.

## 6-1-5 How to use // **RŪ-12**

Press and hold the SETUP key for 2 seconds to enter the Setup Menu. Press ▲ and ▼ keys to select the item to be set, and press SETUP again to enter the settings.

※ Press ← to return to the previous item. Note that the set value will not be saved.



### ◎Frequency Setting

Adjust the left 3 digits of the Frequency. Press ▲ and ▼ keys to change by "+/-" 1 MHz each time. Press the SETUP key after adjustment is completed. Adjust the right 3 digits of the Frequency. Press ▲ and ▼ keys to change by "+/-" 0.025MHz each time. After the setup is completed, press the SETUP key to save the set value.



### ◎Default Group

Press ▲ and ▼ keys to select Group "G:" ; Press the SETUP key adjustment is completed. Press ▲ and ▼ keys to adjust Channel "CH:" After adjustment is completed, press the SETUP key to save the set value.

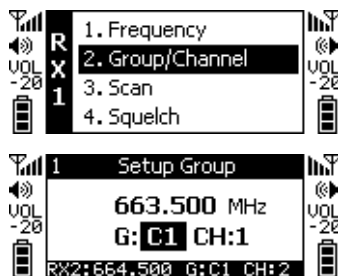

## ◎The Scanning Function

Scan All Groups. Press the SETUP key to start scanning. After the scan is completed, the “Scan Results List” screen will be displayed automatically. Users can also click on the menu to enter the “Scan Results List” directly.

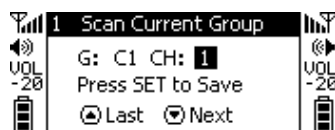
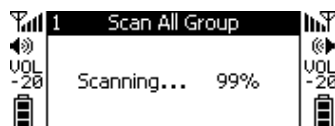
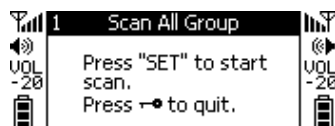
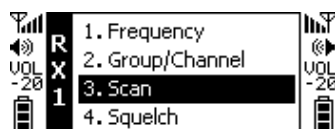

“Scan Results List”: Press the SETUP key to enter the menu screen and view the scan results. Select the available channels, and press the SETUP key to save the settings.



Scanning the current Group: Upon entry into the screen, press ▲ and ▼ keys to select the group to be scanned, and press SETUP to start scanning. Press ▲ to search for the previous available Channel.

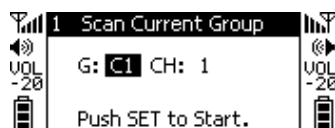
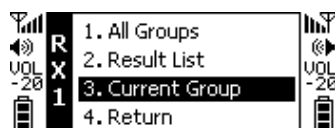

Press ▼ to search for the next available Channel. Press the SETUP key to save the settings.

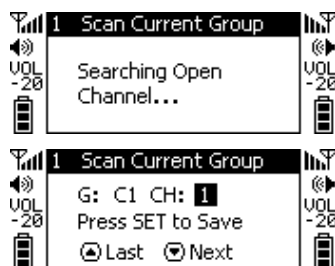

### ⊙Receiver Sensitivity

+10 ~ -5: The higher the value, the lower the Receiver Sensitivity; the lower the value, the higher the Receiver Sensitivity. Default Value is 0.

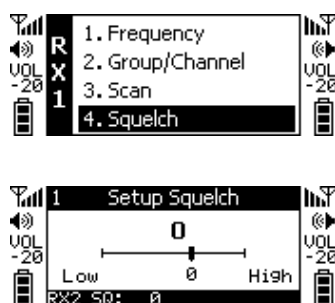

### ⊙Output Attenuation

Press ▲ to set the balanced output level for Line to Line output.

Press ▼ to set the balanced output level for Mic to Mic output.

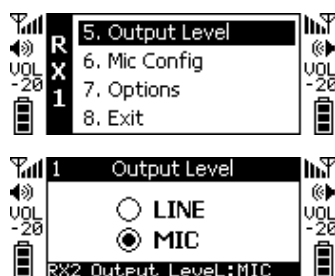

⊙Microphone Options: Press ▲ and ▼ to select the item to be adjusted. Press SETUP, and then press ▲ and ▼ to select the settings to be adjusted, and then press SETUP to return to the item selection.

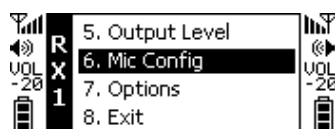



## Sensitivity

Scope of Adjustment:

-15dB~+15dB ; Default Value is 0.

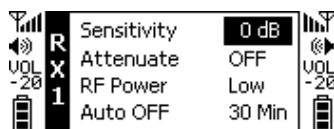
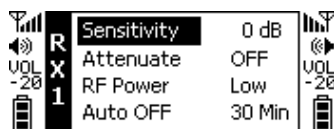

## Input Attenuation

ON	Audio input is attenuated by 20dB. (Depending on whether the transmitter has this function)
OFF	Not Attenuated (Default Value)

This function only applies to the Waist-Mounted Transmitter RU-12TB.

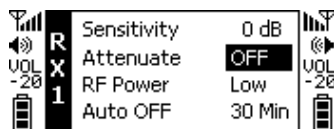
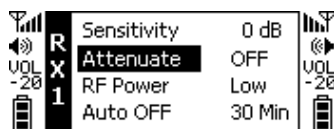

## Radio Frequency Power

High	High Transmitting Power 50mW
Low	Low Transmitting Power 10mW(Default Value)

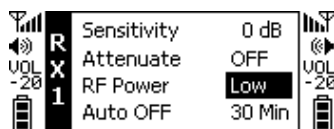
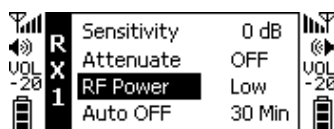

## Automatic shutdown (when the Microphone is muted)

OFF	This function is turned off.
1 min	Automatic shutdown after 1 minute
10min	Automatic shutdown after 10 minutes
30min	Automatic shutdown after 30 minutes

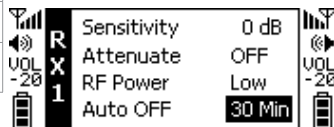
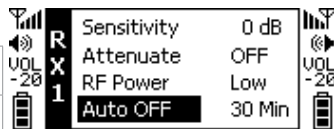

## Synchronization Options

Press ▲ and ▼ to select **REMOSET ũ** and synchronize transmission of the setup items, and then press the SETUP key to perform the selection action.

- Frequency
- Sensitivity
- Input Attenuation (RU-12TB only)
- Radio Frequency Power
- Automatic shut-down
- Digital Audio Code
- Key Lock
- Save and Exit
- Return

### ⊙Key Lock

(Digital anti-interference function)

ON	Key Pad Lock ON
OFF	Key Pad Lock OFF

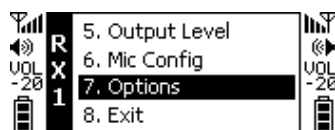
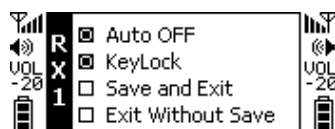
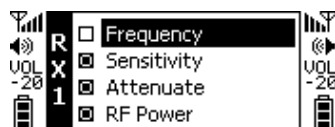
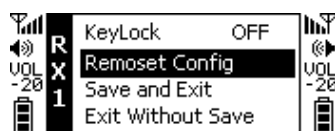
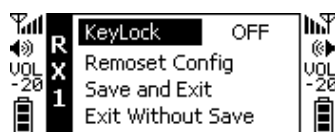

### ⊙System Settings

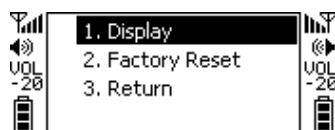

### ⊙Display Settings

Contrast	0~9 (Default Value5)
Brightness	0~9 (Default Value5)

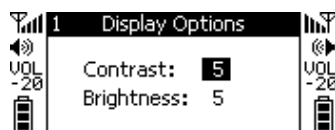

## Language

Yes	Reset to the set values original manufacturer settings
No	Return to the previous option

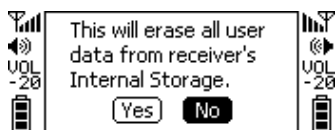

Reset to original manufacturer settings

Exit the Setup Screen.

Press the SETUP key to exit the setup screen and return to the home screen.

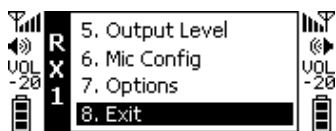

## 6-1-6 How to use// RU-901G3

### Parameter setting

Push and hold the “SET” button to enter the setting mode. Push the ▲/▼ button to choose to set RX (receiver) or TX (transmitter).

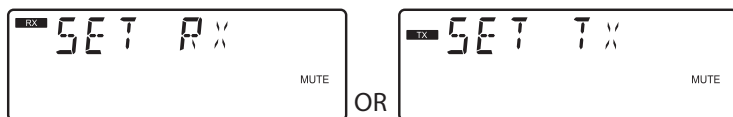

#### When RX receiver is selected:

##### ◎ FREQ: frequency setting

In 1MHz	Select frequency with ▲/▼
In 0.025MHz	Select frequency with ▲/▼



Select the number of frequency first in MHz and then in 0.025MHz.

##### ◎ Group / channel

G: group	Select default group 1~6
CH: channel	Select default channel, 1~23 max



Select the group when “G” is flashing; select the channel when “CH” is flashing.

##### ◎ SQ Receiving sensitivity

-5~+10dB; select SQ with ▲/▼	-5 is the maximum sensitivity.
	+10 is the minimum sensitivity.
	The default setting is 0.

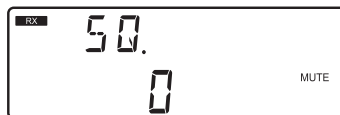

The default setting is 0.

⊙ Channel scan

SCAN oF	This means the function is deactivated.
SCAN on	This means the function is activated. (scan to make sure this channel is occupied or not. The program will avoid it automatically to prevent interference.)

Note: this function works only in the preset mode.



This function is deactivated.

⊙ Audio output attenuation (XLR)

ATT oF	No attenuation at audio output
ATT on	20dB attenuation at audio output

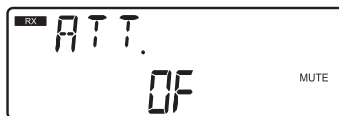

This function is deactivated.

⊙ Key lock

LOCK on	Lock ON
LOCK oF	Lock OFF



When TX transmitter is selected:

⊙ Microphone input sensitivity

Normal sensitivity	GAIN : +15dB
	GAIN : +12dB
	GAIN : +9dB
	GAIN : +6dB
	GAIN : +3dB
	GAIN : 0dB (default)
	GAIN : -3dB
	GAIN : -6dB
	GAIN : -9dB
	GAIN : -12dB
	GAIN : -15dB



It shows the microphone input sensitivity is now at 0dB (default setting).

⊙ ATT microphone audio input attenuation

ATT of	No attenuation at audio input
ATT on	20dB attenuation at audio input (depending on whether the transmitter is provided with the corresponding function).

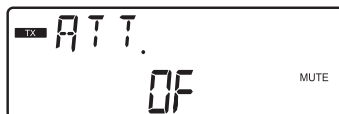

The function is activated with 20dB of audio input attenuation.

⊙ RFP: RF microphone power

The transmitter comes with 2 stages of RF power output (as per local regulations).

Lo	10mW
Hi	50mW

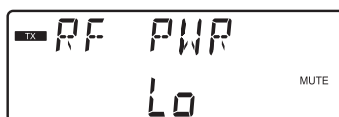

This shows that the RF output is LOW (10mW)

⊙ ATOF: Automatic microphone off countdown under mute status

OF	This function is deactivated
1	1 minute countdown to turn off
10	10 minute countdown to turn off
30	30 minute countdown to turn off

(The default setting is 10 minute.)

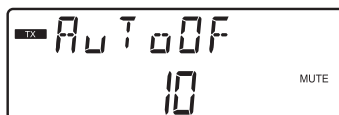

This function is deactivated.

⊙ RC (Remoset Configuration)

RC FRE	Only frequency and group setting will be synchronized
RC ALL	All data setting will be synchronized

The default setting is rC-FrE.



Only frequency and group setting will be synchronized.

## 7. Rack Mounting

- (1) Before mount receivers onto DR-900 rack adaptor, please release any cables from the rear of the receiver.
- (2) Turn over receiver and DR-900 rack adaptor simultaneously, there are 4 threaded holes at the bottom of receiver and rack adaptor for inserting screws.
- (3) Single receiver  
Insert in a receiver through the front of DR-900 until it is firmly attached to the rack, then screw on a RP-900 to another side of the rack.
- (4) Dual receivers  
The same way as above, put one receiver to each rack space.

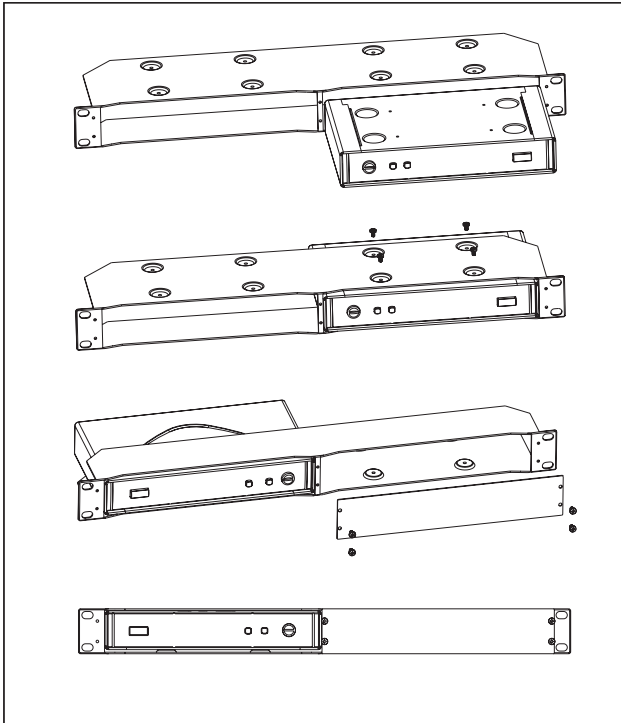

## 8. Recommendation

- (1) In order to achieve the optimum reception condition and also extend the operating distance, please leave on "open space" between the receiver and transmitter.
- (2) Keep the devices away from the metal objects or any interference sources at least 50 cm.
- (3) To avoid the feed-back effect, don't leave the mic. to aim at the speakers directly.
- (4) Remove batteries from the battery compartment when the transmitter will not be used for a long time.



## 9. Important Notice

- (1) JTS offers wireless systems in a selection of bands that conform to the different government regulations of specific nations or geographic regions.  
These regulations help limit radio frequency (RF) interference among different wireless devices and prevent interference with local public communications channels, such as television and emergency broadcasts.
- (2) For information on bands available in your area, consult your local dealer or phone JTS. More information is also available at JTS 's website ([www.jts.com.tw](http://www.jts.com.tw)).
- (3) This Radio apparatus may be capable of operating on some frequencies not authorized in your region. Please contact your national authority to obtain information on authorized frequencies and RF power levels for wireless microphone products.